

AMPEX

OWNER'S REFERENCE MANUAL



PORTABLE
HOME MUSIC SYSTEMS
SERIES 1200

AMPEX

PORTABLE
HOME MUSIC SYSTEMS
SERIES 1200

what it contains:

what it does, and
how to operate it:

care and maintenance:

engineering considerations:

Welcome to the growing family of music lovers whose discriminating tastes have found expression in the ownership of an Ampex. This manual has been prepared so that you may realize the full potential of the quality features engineered into your Portable. It is suggested that you first read the manual.

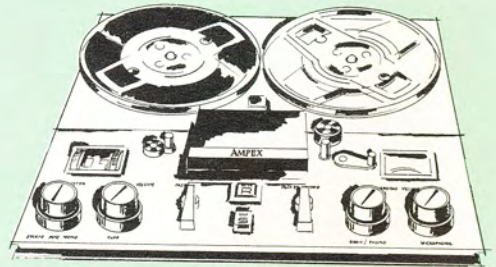

AMPEX STEREO TAPE RECORDER/PLAYER

MAGNETIC TAPE - THE RECORDING MEDIUM

SETTING UP THE EQUIPMENT

ACCESSORIES

- PLAYS MONOPHONIC (SINGLE-TRACK) TAPES
- RECORDS MONOPHONIC TAPES FROM MICROPHONE
- RECORDS MONOPHONIC TAPES FROM EXTERNAL SOURCE
- RECORDS MASTER/STUDENT TAPES FOR USE IN CLASS
- RECORDS "SOUND-ON-SOUND" FOR SIMULTANEOUS RECORDING
- RECORDS SPECIAL EFFECTS, SUCH AS ECHO

DE-MAGNETIZING RECORDER HEADS

CARE OF TAPES -- EDITING AND SPLICING

SPECIFICATIONS

SCHEMATIC WIRING DIAGRAMS OF TAPE RECORDER

FOLD-OUT PAGE. OPEN OUT FOR

carefully, operating the controls of each component to become familiar with its operation and function. When you are ready to perform the various functions noted below, use of the "quick-find" index at right will provide a convenient means of locating the desired section.

TO USE THE "QUICK-FIND" INDEX AT RIGHT: Hold index edge between thumb and forefinger, flip pages until grey panel appears underneath desired index pages.

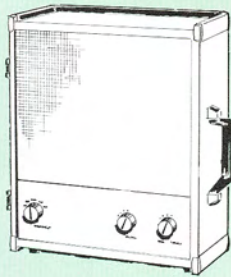

SPEAKER SYSTEMS

1250
1260
TAPE
RECORDER/
PLAYER

1270
TAPE
RECORDER/
PLAYER

2012 1

1

1

1

1

1

1

● PLAYS 4-TRACK STEREO TAPES

1

PHONE ● RECORDS STEREO TAPES FROM MICROPHONES

1

SOURCE ● RECORDS STEREO TAPES FROM EXTERNAL SOURCE

1

IN LANGUAGE AND MUSIC INSTRUCTION

1

NEOUS PLAYBACK OF MULTIPLE RECORDINGS

2

CHAMBER, FADE-IN/FADE-OUT

2

2

2

2

2

2

DER/REPRODUCER AND AUDIO AMPLIFIERS

2

2

USE IN CONJUNCTION WITH PAGES 4 THROUGH 21

2

TAPE RECORDER/PLAYER



The function of the Ampex magnetic tape recorder/player is to capture and store sound as magnetic impulses on the tape, and to translate the impulses back into sound on demand. The instrument incorporates a wide range of control functions and with them is capable of a level of performance normally obtainable only with professional recording equipment.

The recorder/player has been engineered to provide optimum operating results at either of two standard operating speeds— $7\frac{1}{2}$ i.p.s. and $3\frac{3}{4}$ i.p.s. The latter is recommended for recording voice and other sounds where long recording time may be more important than high frequency response. The $7\frac{1}{2}$ i.p.s. speed is used for music and other sounds requiring the highest degree of fidelity throughout the range of human hearing.

The instrument utilizes three separate precision dual-track stacked heads, for 4-track playback, recording, and erasing operations, each especially engineered for its one specific function.

The function of the head—erasing, recording, or playback—takes place at the "head gap." In the playback head, the head gap is a minute vertical space much smaller than the diameter of a human hair, where the two halves of the head structure come together. In recording, a magnetic field across the head gap is imposed on the tiny iron oxide particles comprising the brown coating on the tape. In playback, the changing magnetic field surrounding the oxide particles on the tape induces a fluctuating electrical voltage in the playback head. This voltage is amplified and converted into sound at the speaker.

LOCATION OF CONTROLS AND INDICATORS

The following list outlines the items you will be concerned with on the recorder. Numbers correspond with those in the illustration at right. Notice that the **SELECTOR**, **LISTENING VOLUME** and **RECORDING VOLUME** controls have double knobs; the inside knob and the ring surrounding it are separate controls.

- 1 (Inside Knob) Switches recorder on. Selects monitoring of input or tape. In **INPUT** position, you hear the signal(s) supplied to the recorder; in **TAPE** position, you hear the signal(s) actually recorded on the tape.
- 2 (Outside Knob) Selects monophonic or stereo recording and playback. In **MONO 1** position, input to the left channel (from microphone, tuner, phono, or external source) will be recorded on the upper track (track 1 or 4) with the recording meter showing the level of signal. In **MONO 2** position, input to the left channel will be recorded on the lower track (track 3 or 2) with the recording meter showing the level of signal. In **STEREO**, inputs to both channels will be recorded simultaneously, with meter showing signal level for left channel (at L position) or for right channel (at R). In **MONO ADD** position, input to the left channel (microphone only) will be recorded on the lower track (track 2 or 3) along with the output of the upper track.
- 3 (Inside Knob) Adjusts listening volume for left-channel sound signal.
- 4 (Outside Knob) Adjusts listening volume for right-channel sound signal.
- 5 (Inside Knob) For external, phono or tuner inputs; adjusts level of sound being recorded on left channel.
- 6 (Outside Knob) For external, phono or tuner inputs; adjusts level at sound being recorded on right channel.
- 7 (Inside Knob) For left-channel microphone input; adjusts recording level.
- 8 (Outside Knob) For right-channel microphone input; adjusts recording level.
- 9 Selects tape speed: up position for $7\frac{1}{2}$ ips, down for $3\frac{3}{4}$ ips. **Recorder must be turned on when changing tape speed setting.**
- 10 Recording pushbutton; safety-interlocked with #11—both must be actuated simultaneously to record.
- 11 Turn clockwise to move tape at normal speed from left to right. Locks machine in playback or recording mode of operation.
- 12 Stops tape motion whether recording or reproducing (playing back), regardless of direction or speed. Releases **RECORD** pushbutton when it is locked in the recording position. **Never try to stop tape motion by returning the FAST WINDING or PLAY control to neutral—always use the STOP button!**
- 13 Moves the tape rapidly in either direction. Turn knob in direction you want tape to go.
- 14 Indicates tape position, enables you to return to pre-determined place on the tape.
- 15 Indicates recording level of either left or right channel as selected by control #2.

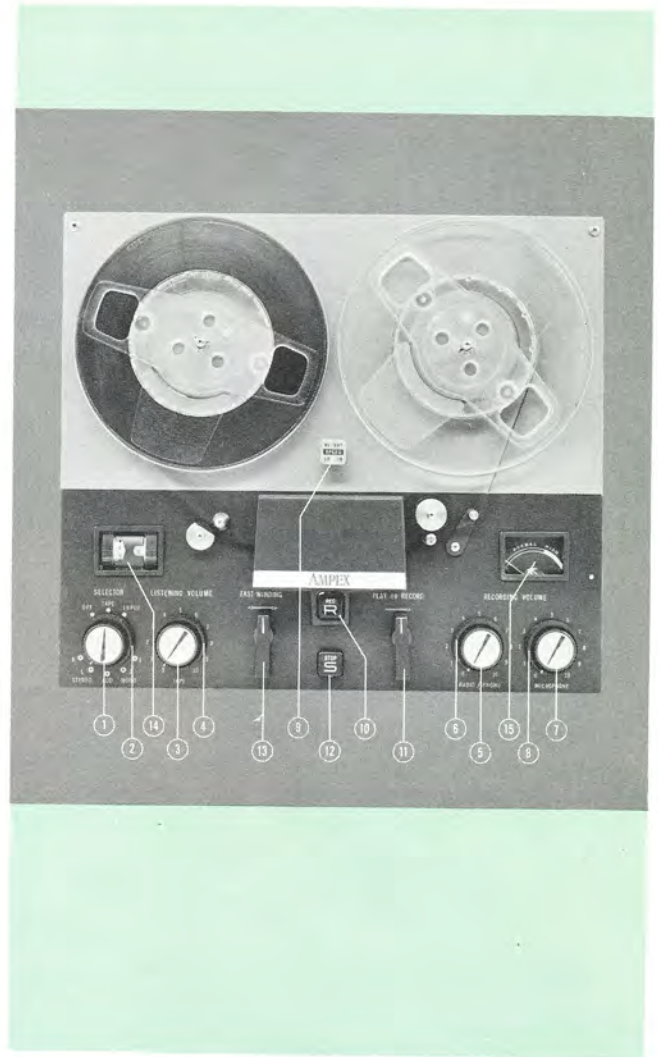

HOW TO THREAD TAPE AND OPERATE THE CONTROLS

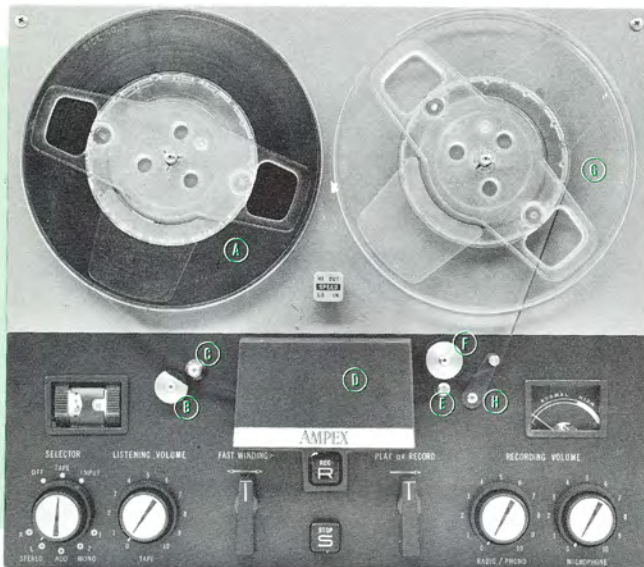

ELEMENTS OF THE TAPE THREADING PATH

- A** Supply reel; may be any standard reel up to and including 7 inches in diameter.
- B** Tape holdback tension regulator
- C** Tape guide
- D** Head cover
- E** Capstan; imparts steady forward motion to tape
- F** Capstan idler; presses tape against surface of capstan
- G** Takeup reel
- H** Automatic-stop arm; stops machine when end of tape is reached

THREADING TAPE ON THE RECORDER

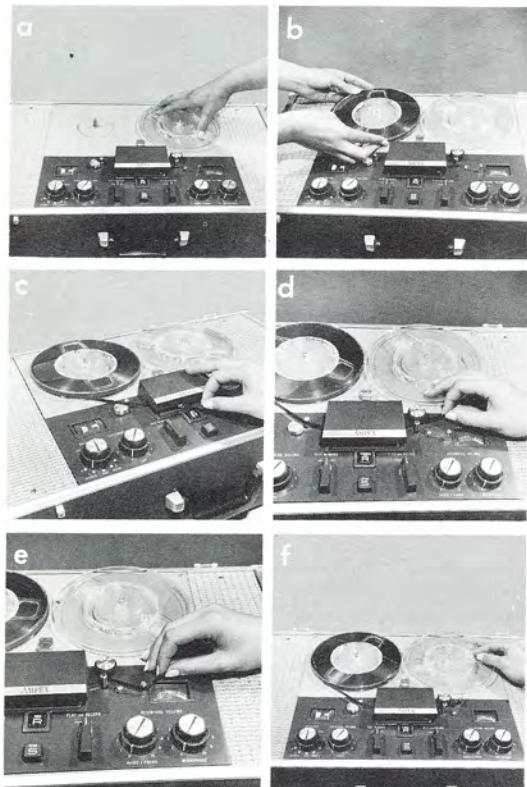

To place tape on the recorder, ready for operation, refer to Figures "a" through "f" and proceed as follows:

1. Place an empty tape reel on the right-hand turntable, in the position of the takeup reel in Figure a. Make sure the slots in the reel engage the turntable.
2. Put a full reel of tape on the left turntable (Fig. b). Tape must be coming off the left side of the reel. Make sure the slots in the reel engage the turntable.
3. Without twisting the tape, pull it off the reel and place it between the holdback tension regulator and the tape guide (Fig. c). Then slip it under the front lip of the head cover and between the capstan and the idler (Fig. d). Check to be sure that the shiny side of the tape faces toward you.
4. Place the tape on the lower side of the automatic stop arm (Fig. e). Then pull the tape up between the flanges of the takeup reel (Fig. f).
5. Turn the PLAY control to start tape motion. Tape should start winding onto the reel hub. Press the STOP button.
6. When editing, turn the knurled wheels on the sides of the tape-position indicator to show zero. Tape is now threaded and you are ready to operate the recorder.

FAST WINDING

The purpose of the FAST WINDING control is to move the tape rapidly from one reel to the other. Using it, a full reel can be unwound in a little over a minute. To check fast winding operation, turn the pointer of the indicator toward the empty reel to the right. The tape should start to wind onto the takeup reel and increase rapidly in speed. After a few seconds, stop the tape by pressing the STOP button. *NOTE:* Always press STOP button first before turning off power switch. Otherwise brakes will not energize and tape can "spill." Then turn the pointer of the FAST WINDING indicator to the left and allow the tape to unwind off the takeup reel. When the tape has come completely off the reel, the automatic stop arm should drop, stopping all rotation of the reels.

STOPPING TAPE MOTION

To stop the tape from moving, either at standard operating speed or at fast winding speed, merely press the STOP button at the center of the tape recorder. This automatically returns the PLAY OR RECORD control or the FAST WINDING control to its rest position (and releases the PRESS TO RECORD push-button if it has been pushed in). Always stop tape motion with the STOP button; never use the on-off switch or try to turn the PLAY OR RECORD or FAST WINDING control to rest position.

SPECIAL FEATURES

An automatic shut-off feature has been included that allows you to turn off the machine (control #1) with the tape still playing. At the end of the tape, the machine will automatically shut itself completely off. It will also shut off any equipment (such as the 2012 speaker-amplifiers) that is plugged into the a-c receptacle on the connector panel.

Ampex Model 1270 Stereo Monitoring Recorder



The Ampex Model 1270 provides the same operational features as the Model 1260, with the additional feature of a self-contained 3-watt stereo amplifier-speaker system (1.5 watts per channel; total peak power output 6 watts). Though external amplifier-speakers such as the Ampex Model 2012 or equivalent are recommended for utilizing the full performance capabilities of the 1270's recorder/reproducer, the unit's built-in amplifier-speakers provide a high degree of flexibility and utility for their designed purpose of stereo monitoring.



OUTPUT CONNECTIONS

In place of the output jacks on the Model 1260, the Model 1270 provides an additional connection panel containing a left and right channel external amplifier jack and a left and right channel headset jack.

EXTERNAL AMPLIFIER JACKS—The signal available at the external amplifier jacks is the output of the tape recorder (approximately 0.75 volts rms from cathode follower). The function of these jacks is identical with that of the tape recorder output jacks in the Model 1260. When used, these jacks automatically disconnect the internal monitoring amplifier system.

HEADSET JACKS—The phone jacks are connected to the output of the internal monitor amplifiers (3.2 ohms) and may be used for monitoring through headsets such as the Ampex 881, or may be connected to full range external speakers with approximately 4-ohm voice coils. With headsets plugged into these jacks, the monitor speakers are automatically disconnected.

INPUT CONNECTIONS

RADIO-PHONO—Inputs for radio-phono are located in the center opening at the back of the Model 1270 and will accept standard RCA phono plugs. Approximately 0.25 volts rms are required for maximum normal recording level.

MICROPHONE—Microphone inputs are located in the left-hand opening (when facing the back), and are labeled L and R, respectively. The inputs require high impedance microphones, such as the Ampex Model 880. A 1-amp fuse for the monitor amplifiers is also located on this panel.

TONE CONTROL

On the right end panel, facing the front of the recorder, you will find the tone control which is labeled TREBLE plus and minus. With the control in the full clockwise position, the frequency response of the amplifier is flat over its specified frequency range. In the extreme counter-clockwise position, the treble signals are attenuated and a setting between the full clockwise and full counter-clockwise position can be selected to provide the most pleasing monitor response in the immediate listening area.

ADJUSTABLE SOUND DIRECTORS

On both the right and left end panels, toward the front, you will find a small knob. Rotation of this knob unlatches the sound directors, which may be adjusted to an angle between zero and 80° from the end of the case. The angle at which the directors are set is adjusted as desired to provide the most desirable stereo acoustical pattern in the immediate monitoring area.

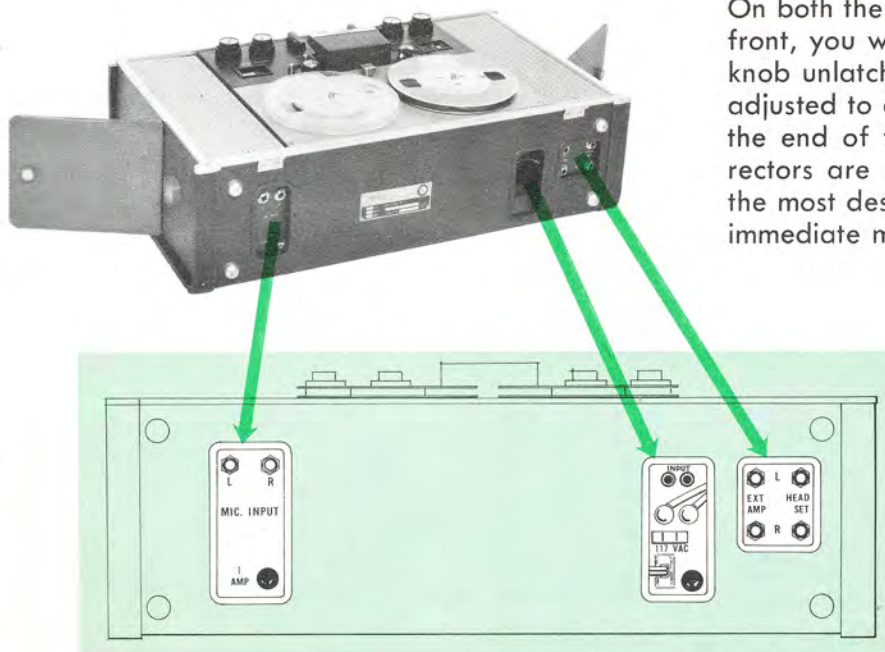

Ampex Model 2012 Amplifier/Speaker



Ampex Model 2012, finished in satin-grey vinyl to match the Ampex portable recorder/reproducer

The Ampex Model 2012 is an electronically and acoustically integrated system of components designed to present to the ear a completely accurate, undistorted re-creation of the original sound. The amplifier-speaker utilizes a powerful 10-watt (20-watt peak) amplifier and a specially designed 8" sound projector with an acoustically correct enclosure. Individual balance and tone controls are located on the front panel, and input jacks are provided for audio signals from any external source. A front-panel selector switch enables you to select sound from tape, phonograph, radio, or TV sound, without the necessity for changing input wires at

the connection panel. Specifications are on page 24; wiring diagram on page 27.

EXTERNAL JACK

For use with earphones or external speakers, you may wish to add an external jack to your Model 2012, or have your dealer add it. A recommended location is on the ventilator plate at rear. Use a closed-circuit transfer jack, wiring it into the circuit between the speaker and the amplifier output. (See diagram.)

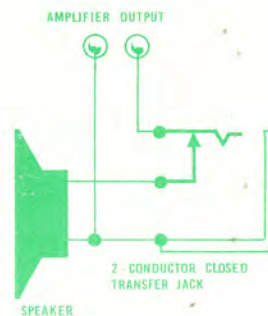

the Recording Medium-- Magnetic Tape

Magnetic tape is a plastic film coated with millions of tiny particles of magnetic oxide (which give the tape its brown color). To store a sound on this tape, it is necessary to convert the sound into an electrical current. This current, flowing through the recording head on your tape machine, causes an electromagnetic field to vary in accordance with the fluctuations in the sound. The oxide particles on the tape, as they pass the recording head, are magnetized by the varying electromagnetic field. On playback, the magnetized tape passes the playback head and induces an electrical current corresponding to the sound that the tape "remembers." This current is amplified and transformed back into sound energy.

Magnetic tape's "memory" does not wear out or deteriorate with age. The tape remains magnetized indefinitely, until erased or brought into contact with a strong magnetic field. It can be erased and re-recorded innumerable times with no loss in its ability to capture and play back sound or other information which can be converted into electrical signals.

TYPES OF TAPES

Both monophonic and stereophonic recordings can be recorded on the 1200 series recorders. A monophonic recording is one in which only single-channel sound is recorded on the tape. A monophonic tape is generally recorded its full length and then turned over for recording on its second track back to the beginning of the reel. In 'four track' monophonic recording this process is repeated again so that all four tracks are used for four separate recordings which provides four times the available recording time.

A stereophonic recording is one which uses two sound tracks. Stereophonic tapes are available in two types: 2 track and 4 track.

The 2 track stereo tape has both sound tracks recorded side-by-side for the full length of the tape for one recording only and therefore must be rewound when the end is reached.

The 4 track stereo tape is recorded on alternate tracks so that the first recording goes on tracks 1 and 3 for the full length of the tape and is then turned over to record on tracks 2 and 4 back to the beginning of the reel. This effectively provides twice the recording time of a 2 track stereo tape.



In MONOPHONIC RECORDING, the tape is recorded on one-fourth its width.



When the end of the reel is reached, the tape is turned over, and the second track is recorded in the opposite direction.

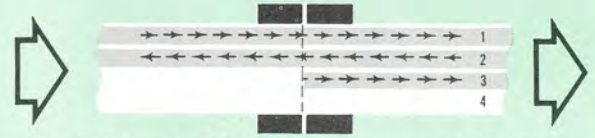

When the end of the second is reached, the tape is again turned over, and the third track is recorded in the same direction as the original recording.

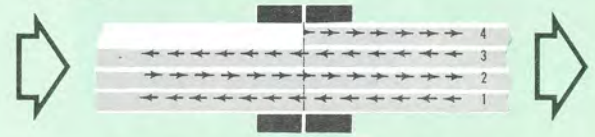

The reel is again turned over and the final track is recorded.



In 4-track STEREO RECORDINGS, the two stereo channels are recorded on non-adjacent tracks in one direction, (tracks 1 and 3 as shown above) from one end of the reel to the other.



At the end of the reel, the tape is turned over and recorded on the alternate tracks (tracks 2 and 4 as shown above).

Handling Magnetic Tape

Tape is a strong, permanent recording medium, unaffected by ordinary handling or storage. However, it should be kept away from heat and moisture, and direct contact with other magnetic materials. Avoid stretching tape, or you will distort it and destroy the quality of the recording.

How to set up your Ampex Stereo System

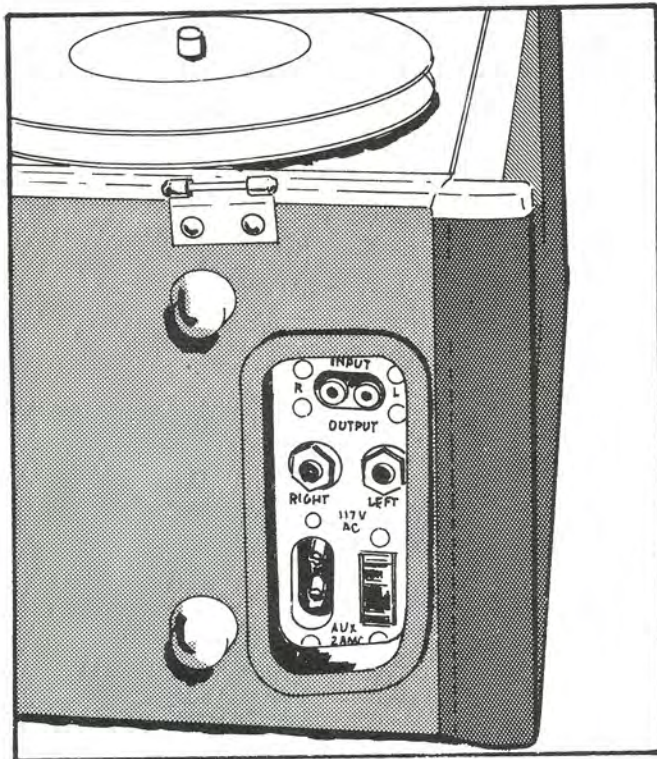

Connector panel, Ampex Model 1260

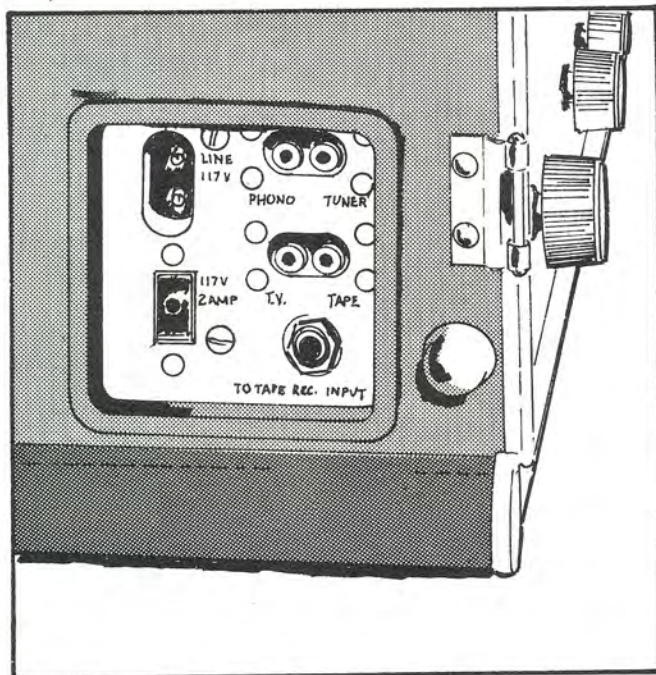

Connector panel, Ampex Model 2012

Though there is nothing critical about placement of the units in your Ampex stereo system, a few general suggestions are noted here. In the average room, speakers may be placed against a wall, separated by a distance $\frac{1}{3}$ to $\frac{1}{2}$ the width of the room. Corner placement is not recommended, nor should the speakers ever face inward.

Packed with a complete portable system you will find grey signal cables and black power cables. In the grey cable bag with the recorder you will also find two pin jack connectors for input cables, and two black phone plugs for output cables. Shielded (metallic) phone plugs are also included for use with microphone input cables. When you use these connectors, take care to connect the center conductor of the cable to the center-conductor terminal of the plug.

Connect power to the system as shown in the diagram on the opposite page, using the black power cables. Turn the SELECTOR control on each amplifier-speaker to TAPE. Now the power to all units is controlled by the on-off SELECTOR switch on the tape recorder. Connect the grey signal cables as shown in the diagram.

CHECKING BALANCE

If, upon operating your system, you would like to determine that your speaker system is in balance, go through the following procedure, referring to pages 4 and 5 and identification of controls and indicators:

1. Turn on system power, switching (1) to TAPE. Set selector (2) to MONO 1. Set both listening volume knobs (3 & 4) to the same setting, at approximately 5. Place a recorded tape on the machine and play it back in accordance with instructions on page 14.
2. At the speakers, make sure, that BASS-TREBLE controls are at identical settings.
3. Stand in front of the speakers, at a point equidistant from both. Have someone adjust the VOLUME controls on the amplifier-speakers until the sound appears to originate midway between them.
4. Note the settings of the VOLUME controls; use the same relative settings and regulate the volume from controls 3 & 4 on the tape recorder.

2012 AMPLIFIER LOUDSPEAKER

1260 TAPE RECORDER

2012 AMPLIFIER
LOUDSPEAKER

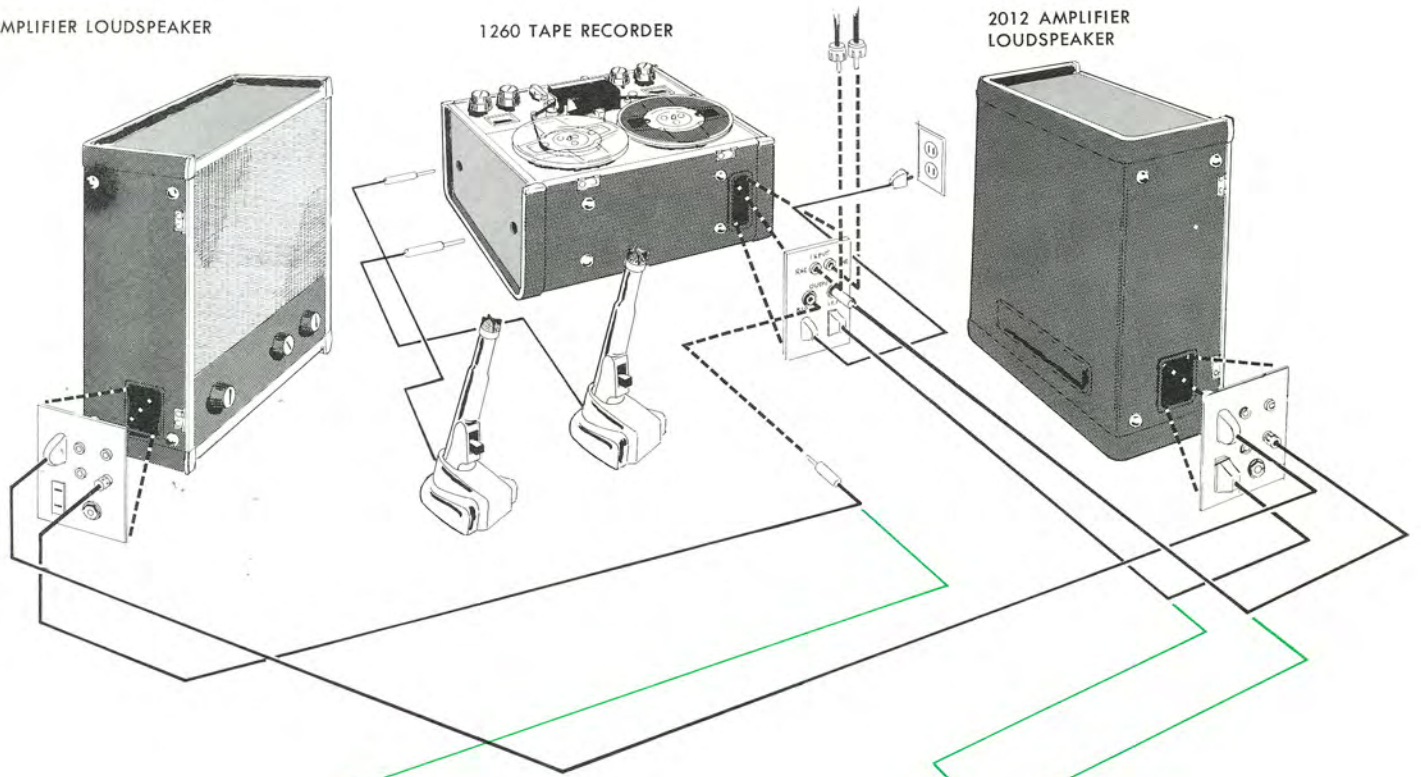

AMPLIFIER

AMPLIFIER

LOUDSPEAKER

LOUDSPEAKER

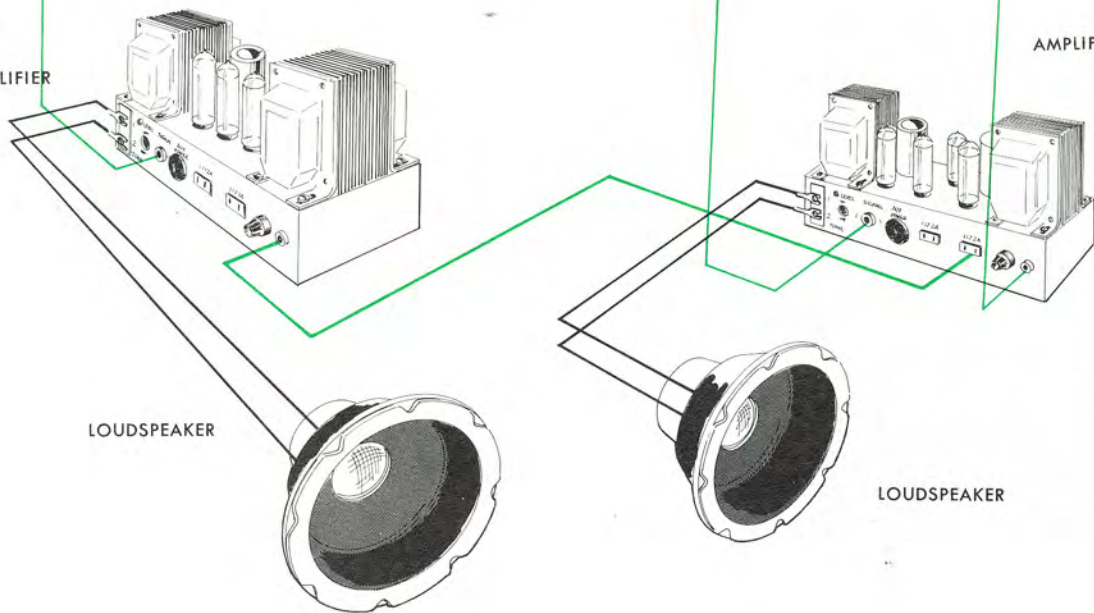

Upper portion of drawing shows the Ampex recorder/reproducer used in conjunction with Model 2012 amplifier-speakers. The lower diagram indicates the manner in which another type of amplifier-speaker should be connected to the system.

2012 AMPLIFIER
LOUDSPEAKER

AUDIO CONTROL CENTER

AM-FM STEREO TUNER

PHONO

1260 TAPE RECORDER

2012 AMPLIFIER LOUDSPEAKER

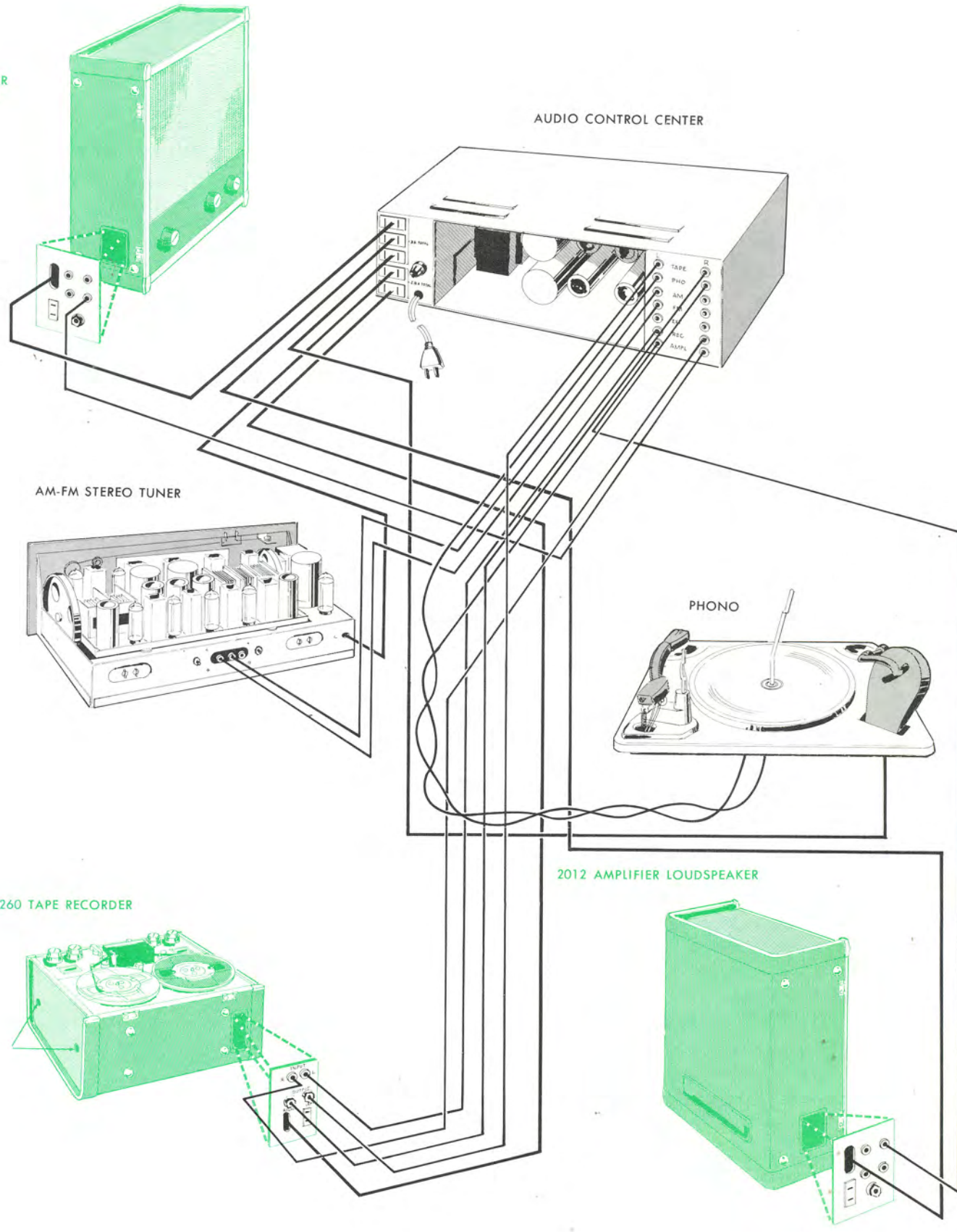

ACCESSORIES

AMPEX MICROPHONE

The Ampex Model 817 Microphone consists of a omnidirectional dynamic microphone with desk-mounting base for recording. Optimum frequency response is provided in the critical range from 60 to 12,000 cycles per second. The microphone incorporates an on-off switch and is equipped with a detachable 8-foot cable terminating in a standard 2-conductor phone plug for connecting directly to the microphone input of the recorder. Two microphones would be required for stereo.

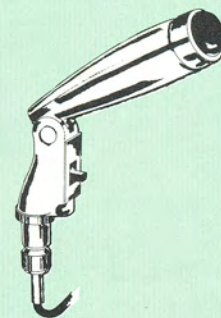

AMPEX 2 TRACK—4 TRACK CONVERSION KIT

The 1200 Series recorder/reproducers are intended primarily for the reproduction of 4-track tapes. An accessory conversion kit (Ampex Model 105) is offered for those who also wish to reproduce 2-track tapes and obtain optimum performance. The conversion kit consists of a shift plate assembly, a post, a stud, a shift lever, a head cover, and miscellaneous hardware.

DEMAGNETIZER, HEAD CLEANER

These Ampex accessories are recommended for use with your Ampex tape recorder/player. Their use is described on page 22.

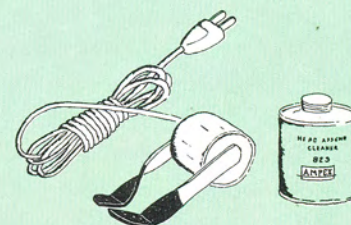

These Ampex Accessories are available through your local authorized Ampex dealer or serviceman.

Operating Procedures

Before playing tapes on your recorder/reproducer, it is particularly important that you be reminded of the proper use of certain operating controls. Never press the RECORD button unless you are actually recording.

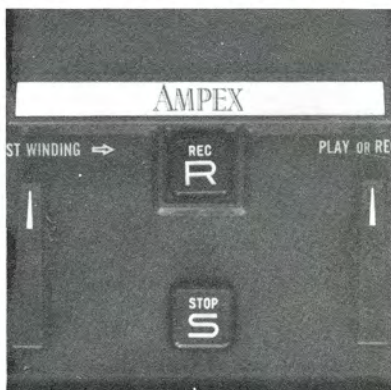

HOW TO USE THE CONTROL SETTING CHARTS BELOW AND ON FOLLOWING PAGES:

Accompanying each mode of operation is a control setting chart incorporating drawings of only those components involved. On each drawing, a colored dot designates the controls you will be concerned with. Controls without a designating colored dot are set at zero, or if pushbuttons, left in the OUT position. While setting up the controls it will be helpful to open out fold-out page 28 until you have become completely familiar with controls and functions.

NOTE: See Page 6 — How to Thread Tape

TO PLAY 4-TRACK STEREO TAPES

Set controls as noted in chart at right. Turn PLAY-RECORD knob (#11) clockwise to start. Since 4-track tapes are recorded in both directions, let the tape play out fully to the end; then exchange right and left reels, turning both reels over in the process. At the end of the second "side" of the tape, it will have been rewound on to the original reel, ready to play the next time you wish to hear it.

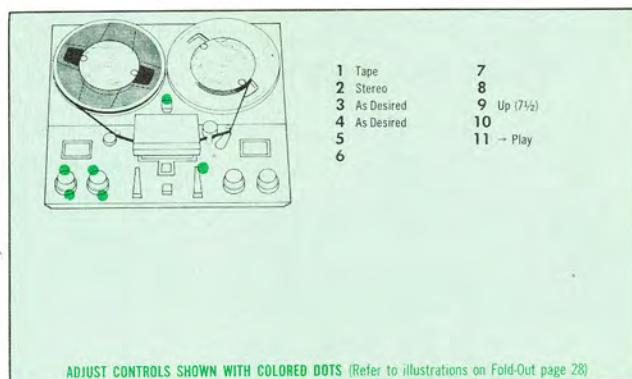

TO PLAY MONOPHONIC (SINGLE-TRACK) TAPES

Set controls as noted in chart at right. The SELECTOR (#2) can be in either MONO 1 or MONO 2 position depending on which of the four tracks is to be played. (See page 5.) Turn PLAY-RECORD knob (#11) clockwise to start. If the tape is recorded in both directions, let it play out fully to the end. Then, after the entire length has been wound onto the takeup reel, exchange reels, turning both reels over in the process. Thread tape and play second "side."

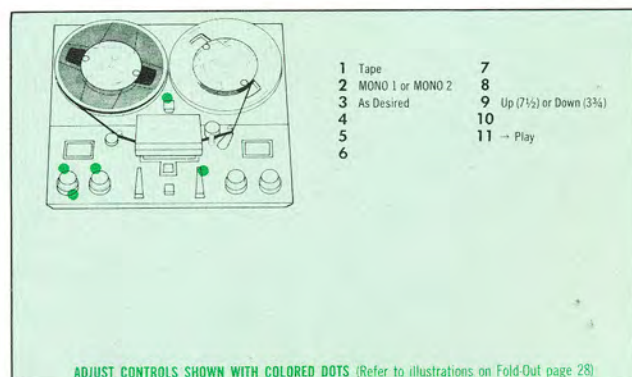

IMPORTANT NOTE

While operating the recorder/reproducer in the RECORD mode, it is advisable NOT to rotate the outer SELECTOR knob except between STEREO L and STEREO R.

TO RECORD MONOPHONIC TAPES FROM A MICROPHONE

Set controls as noted in chart at right. The SELECTOR (#2) can be in either MONO 1 or MONO 2 position depending on which of the four tracks is to be recorded. (See page 5.) Plug a microphone into the LEFT microphone jack, and place it in front of the person or sound source to be re-

corded. Exact distance between microphone and person speaking can vary upwards from a minimum of a few inches; however, it must be close enough to register a normal indication on the recording level meter (the needle should fluctuate in the area marked "NORMAL," with only the loudest peaks swinging into the white portion of the scale).

Before recording, it is suggested that you check the tape you are recording in playback mode, to make sure that the tape does not contain previously recorded material which you want to preserve. Thread the tape as described.

When you are ready, press the RECORD pushbutton (#10) as you turn the RECORD control (#11) to begin recording.

TO RECORD STEREO TAPES FROM MICROPHONES

Set controls as noted in chart at right. Plug microphones into both LEFT and RIGHT microphone jacks. With recording SELECTOR (#2) in STEREO (L) position, adjust the left channel MICROPHONE VOLUME control (#7) for a normal indication on the recording level meter while someone speaks into the left channel microphone. Now place SELECTOR (#2) in STEREO (R) position, and adjust the right channel MICROPHONE VOLUME control (#8) for a normal indication on the meter, using the right channel microphone. Press the RECORD pushbutton (#10) simultaneously with turning the RECORD control (#11) to begin recording.

MICROPHONE PLACEMENT

In stereo recording, the distance between the two microphones must be determined by the acoustics of the room and the preference of the person recording. A workable rule-of-thumb, the "Equilateral" method, consists of placing the microphones as shown at right, at the halfway point on the adjacent sides of an equilateral triangle with sides equal to the maximum width of the source of sound.

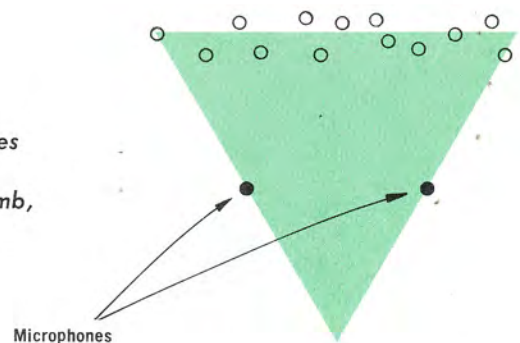
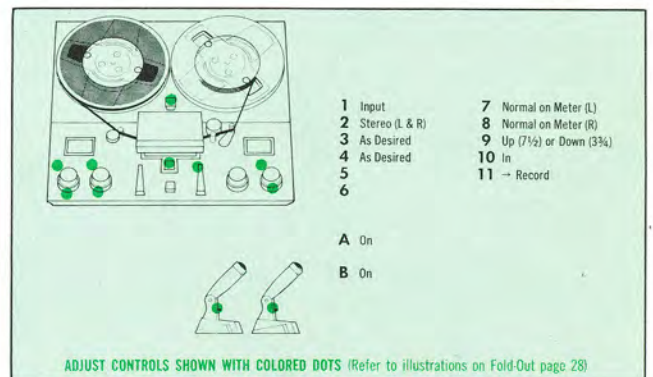
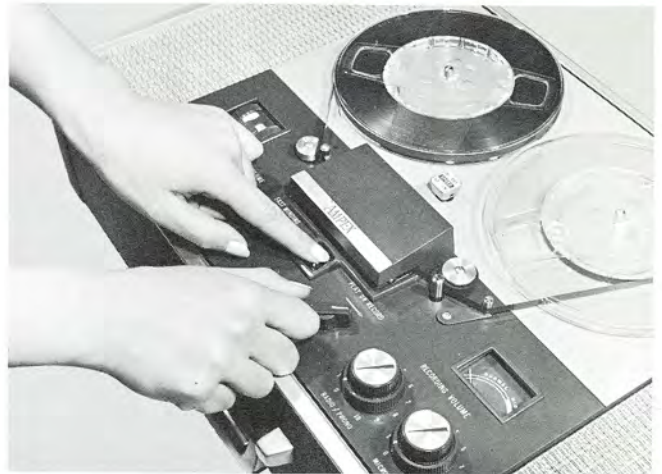
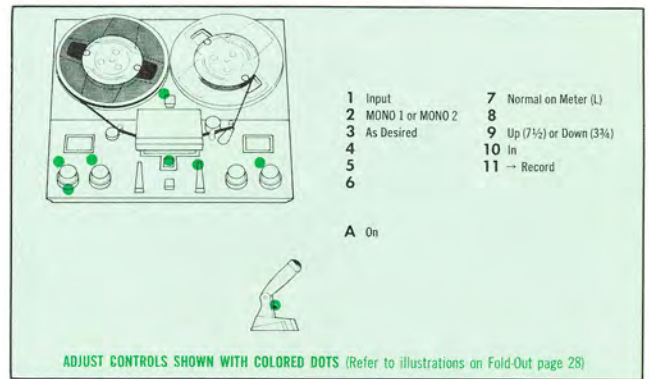

TO RECORD MONOPHONIC TAPES FROM AN EXTERNAL SOURCE

Set controls as noted in chart at right, and connect the external source into the left channel as shown on page 12 or 13. The SELECTOR (#2) can be in either MONO 1 or MONO 2 position depending on which of the four tracks is to be recorded. (See page 5.) Adjust RADIO/PHONO VOLUME control (#5) for normal on the recording meter, with a signal being supplied from the external source. To record, press the RECORD pushbutton (#10) simultaneously with turning the RECORD control (#11). To compare the original sound with the recording, vary SELECTOR (#1) between INPUT and TAPE.

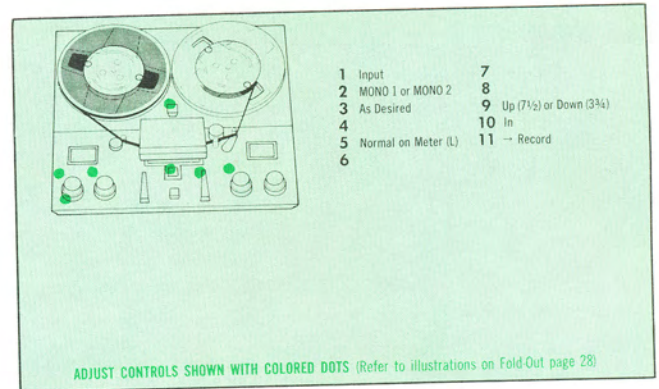

TO RECORD STEREO TAPES FROM AN EXTERNAL SOURCE

Set controls as noted in chart at right. Connect the two separate channels of the stereo input signal to the left and right input jacks. With a signal being supplied, adjust the left channel RADIO/PHONO VOLUME control (#5) for normal on the recording level meter and SELECTOR (#2) in STEREO (L) position; adjust the right channel RADIO/PHONO VOLUME control (#6) for normal on the recording level meter with SELECTOR (#2) in STEREO (R) position. Press the RECORD pushbutton (#10) simultaneously with turning the RECORD control (#11).

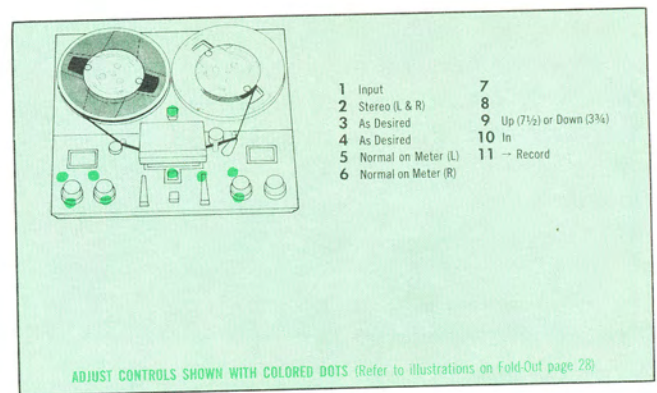

TO RECORD MASTER-STUDENT TAPES FOR LANGUAGE/MUSIC INSTRUCTION

RECORDING MASTER TRACK. Set controls as shown in chart at right. Recording will be made on left channel track. Plug the microphone into the LEFT microphone jack. Establish proper recording level by adjusting the left channel MICROPHONE VOLUME Control (#7), while speaking or playing into the microphone, for a normal indication on the meter. Record instructor's material with sufficient pause between phrases or passages to allow the student to record his interpretation later on.

RECORDING STUDENT TRACK. Set controls as shown in chart at right. Establish recording level for instructor's voice by playing back the tape and adjusting left channel RADIO/PHONO VOLUME control for a normal indication on the meter. Establish recording level for student's voice by adjusting left channel MICROPHONE VOLUME control, while speaking or playing into the microphone, for a normal indication on the meter. Both the instructor's voice and the student's voice will be recorded on the lower track.

Although student can listen to instructor's track over the loudspeakers, with the volume turned relatively low, it is more desirable to use headsets while recording student track. If headsets are used for this step, plug into LEFT channel.

PLAYBACK FOR COMPARISON. Set controls as shown in chart at right. When you place recorder in playback mode of operation with control (#11), and adjust volume control, you will be able to hear a direct comparison of the instructor's efforts with those of the student. Though you may wish to save portions of the tape for later comparison purposes, you may re-record the student track any number of times, repeating the step above, without altering the instructor track.

1 Input	7 Normal on Meter
2 MONO 1	8
3 As Desired	9 Up (7½) or Down (3¾)
4 As Desired	10 In
5 As Desired	11 → Record
6 As Desired	
A On	

ADJUST CONTROLS SHOWN WITH COLORED DOTS (Refer to illustrations on Fold-Out page 28)

1 Input	7 Normal on Meter
2 MONO ADD	8
3 As Desired	9 Up (7½) or Down (3¾)
4 0	10 In
5 Normal on Meter	11 → Record
6 As Desired	
A On	

ADJUST CONTROLS SHOWN WITH COLORED DOTS (Refer to illustrations on Fold-Out page 28)

1 Tape	7
2 MONO 2	8
3 As Desired	9 Up (7½) or Down (3¾)
4 As Desired	10 In
5 As Desired	11 → Play
6 As Desired	
A On	

ADJUST CONTROLS SHOWN WITH COLORED DOTS (Refer to illustrations on Fold-Out page 28)

TO RECORD SOUND-ON-SOUND

RECORDING MASTER TRACK. Set controls as shown in chart at right. Recording will be made on left channel track. Plug the microphone into the LEFT microphone jack. Establish proper recording level by adjusting the left channel MICROPHONE VOLUME control (#7), while speaking or playing into the microphone, for a normal indication on the meter. NOTE: Both an external source (radio, phono, etc.) and a microphone can be recorded simultaneously. If an external source is used, adjust the left channel RADIO/PHONO VOLUME control (#5) for a normal indication on the meter.

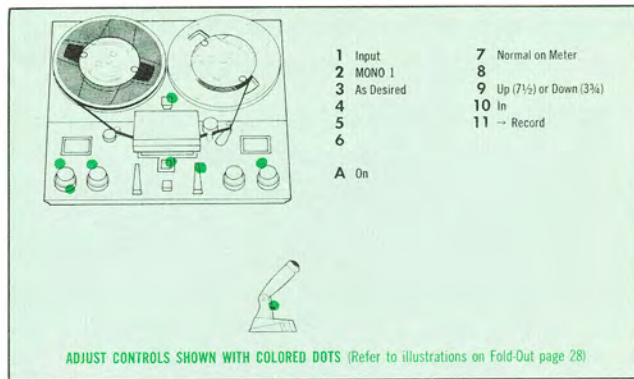

RECORDING THE SECOND TRACK. Set controls as shown in chart at right. Establish recording level for original recording by playing back the tape and adjusting left channel RADIO/PHONO VOLUME control (#5) for a normal indication on the meter. Establish the second track recording level by adjusting left channel MICROPHONE VOLUME control, while speaking or playing into the microphone, for a normal indication on the meter. Both the original performance and the second performance will be recorded on the right channel.

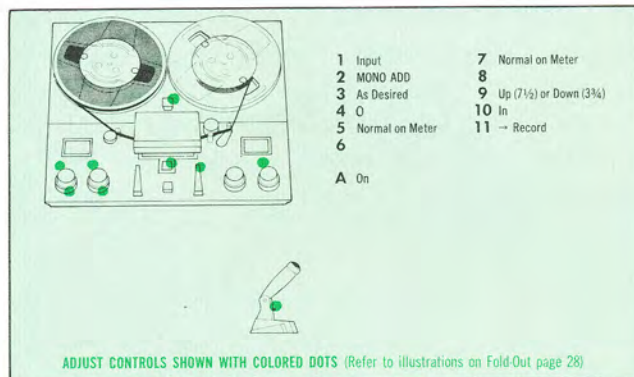

Although you can listen to the first track over the loudspeakers, with the volume turned relatively low, it is more desirable to use headsets while recording second track. (See below for details.) If headsets are used for this step, plug into LEFT channel.

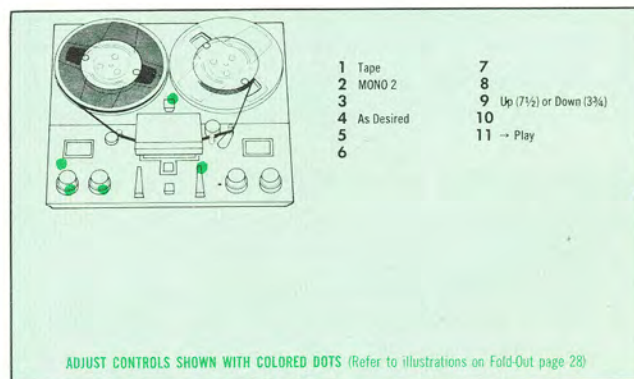

PLAYING BACK THE FINAL RECORDING. After completing the recording, set the controls as shown in chart at right. Note that only two tracks can be recorded "sound-on-sound."

ECHO-CHAMBER EFFECTS

Set controls as shown in chart at right. Plug a microphone into the LEFT microphone jack. Begin recording, and slowly turn up the left channel LISTENING VOLUME control (#3) to the point where you hear the repetition of sounds spoken into the microphone. You can vary the echo by experimenting with different volume levels and different tape speeds. Be cautious about too high a volume, or getting the microphone too close to the speaker, or the sound may get out of hand. When it does, simply press the STOP button.

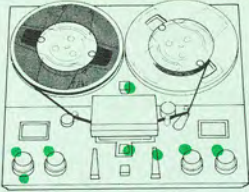

1	Tape	7	Normal on Meter
2	MONO 1 or MONO 2	8	(Normal on Meter)
3	As Desired	9	Up (7½) or Down (3¼)
4		10	In
5	10	11	→ Record
6			
A	On		

ADJUST CONTROLS SHOWN WITH COLORED DOTS (Refer to illustrations on Fold-Out page 28)

SPEECH-TESTING GAME

Set controls as shown in chart at right. Plug a microphone into the LEFT channel jack. Headsets are necessary. Wearing them, place the recorder in RECORD mode and turn up the left channel LISTENING VOLUME control (#3) until sound level in the headphones is high. Hand the headset and microphone to an unsuspecting guest and ask him to recite "Mary had a little lamb". . . then watch the fun! What happens is that the time delay between spoken and reproduced speech (1/6 second), at high volume, is enough to be thoroughly confusing to our speech/auditory senses, and coherent speech requires great concentration.

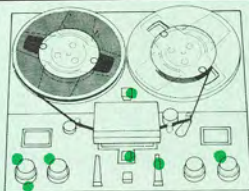

1	Tape	7	Normal on Meter
2	MONO 1 or MONO 2	8	(Normal on Meter)
3	5-6	9	Up (7½)
4		10	In
5		11	→ Record
6			
A	On		

ADJUST CONTROLS SHOWN WITH COLORED DOTS (Refer to illustrations on Fold-Out page 28)

FADE-IN/FADE-OUT EFFECT ("MIXING")

Set the controls as shown in chart at right, and connect the desired source of sound. Establish recording level for that source by adjusting the left channel RADIO/PHONO VOLUME control (#5), noting the setting, and returning the control to zero. Plug microphone into LEFT channel input, and establish recording level with MICROPHONE VOLUME control (#7), again noting setting, and returning control to zero. To fade in voice over music, place machine in RECORD mode with control (#5) at pre-established setting. Then simultaneously return control (#5) toward zero while bringing control (#7) up from zero to pre-established setting. Reverse the process to fade from voice to music. This can also be done in stereo.



1	Input	7	Normal on Meter
2	MONO (or STEREO)	8	(Normal on Meter)
3		9	Up (7½) or Down (3¼)
4		10	In
5	Normal on Meter	11	→ Record
6	(Normal on Meter)		
A	On		
	On		

ADJUST CONTROLS SHOWN WITH COLORED DOTS (Refer to illustrations on Fold-Out page 28)

MAINTENANCE PROCEDURES

CARE OF HEADS

Dust and oxide from magnetic tape may accumulate on the magnetic heads of the tape recorder and impair their efficiency. To avoid this, you should periodically clean all the items in the tape-threading path.

To clean the heads, use a Q-tip moistened in a solution of Xylene and 0.1% Aerosol (available as a standard Ampex Audio accessory, #823). Be sure to remove head cover, and keep cleaning solution away from plastic parts. **DON'T USE ANY OTHER SOLVENTS ON THE HEADS**, or you may damage them. Never use an abrasive or any metallic object which might cause scratches or nicks.

For cleaning the capstan, capstan idler and tape guides, use a clean lintless cloth moistened with denatured or isopropyl alcohol.

DEMAGNETIZING THE HEADS

Occasionally the heads may become slightly magnetized through continued use. If this condition is not corrected, you may find the noise level of your tapes increasing, recorded signals becoming distorted and, in extreme cases, the high frequencies

Head cover is removed by slight pressure forward, then pulling upward.



Cleaning solution is applied with cotton swab applicator.

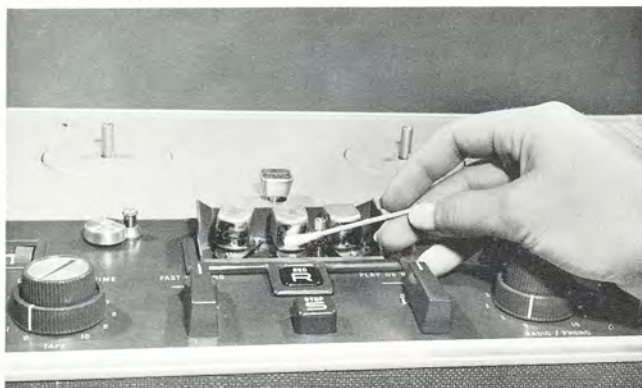

on recorded tapes gradually being erased. This condition can be corrected with a Head Demagnetizer (available from your local dealer as Ampex Audio accessory #820). To use the demagnetizer:

1. Press the head cover forward and remove. Loosen the Phillips-head screw at the rear of the metal head shield and lift off the shield. Switch the SELECTOR to OFF.
2. Plug the head demagnetizer into a wall outlet (117 volts ac).
3. Align the tips of the demagnetizer to the recording (center) head so that they straddle the head gap. Don't touch the surface of the head with the metal tips of the demagnetizer. Run the tips up and down the head several times and slowly withdraw the demagnetizer.
4. Repeat the above for the playback (right) head. It's not necessary to demagnetize the erase head.

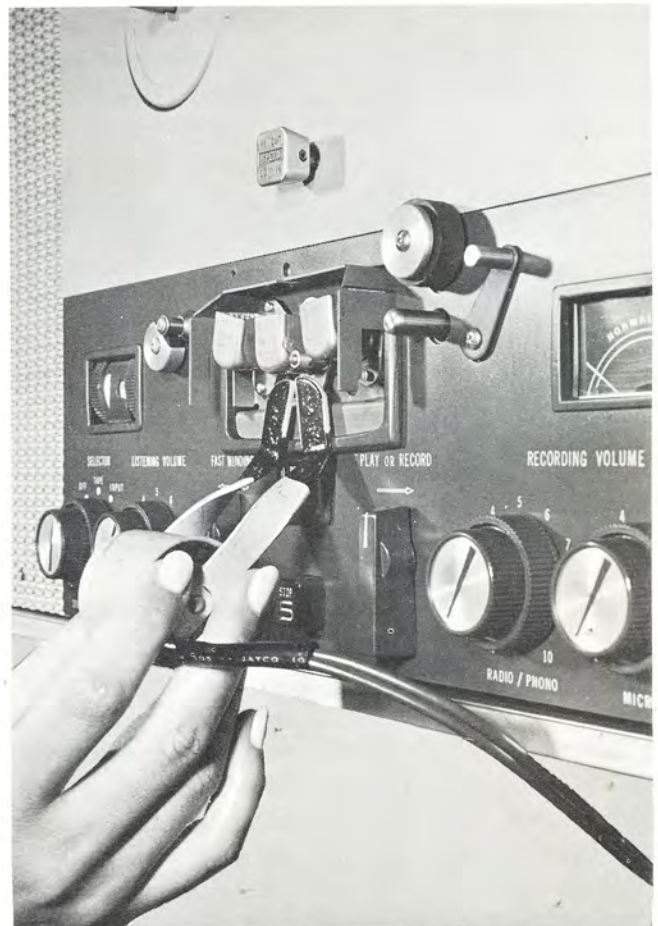

In demagnetizing, tips of demagnetizer are brought within 1/16" of head gap (but not touching), and gradually moved away while being moved up and down along head gap.

Editing and Splicing Tapes

EDITING BY ERASURE

Extraneous noise or conversation between selections can easily be erased by using the erase head on the tape recorder. Turn all RECORDING VOLUME controls (5, 6, 7 & 8) to zero and put playback SELECTOR control (1) in SINGLE or STEREO, depending on type of recording. Run the tape in the fast-winding mode to the point to be erased. (The exact place to be edited can be located by rotating the reels manually and listening to the output of the speaker. Be sure to allow for the space between recording and playback heads. Then note the points to start and stop erasing on the tape position indicator.) Press the RECORD pushbutton (11) as you turn the RECORD control (12) to start tape motion. When you reach the point where the next selection starts, press the STOP button. Another way of accomplishing this is to hold the PLAY OR RECORD control in its full clockwise position and hold the STOP button down, as the tape is moving. The RECORD pushbutton will not lock in position and can be pressed and released as desired.

COMPLETELY ERASING RECORDED TAPES

The tape will be erased during the recording process, so it isn't necessary to completely erase before re-recording. However, if there are to be gaps between newly-recorded sections of the tape, and you wish to avoid having previously recorded material in the gaps, leave the "record" pushbutton in, with recording level at zero, between sections you are recording. Completely erasing the tape before re-recording can lessen your editing problems. If bulk erasing facilities are not available, complete erasure can be accomplished by running the tape in the recording mode at 7½ ips with all RECORDING VOLUME controls set at zero.

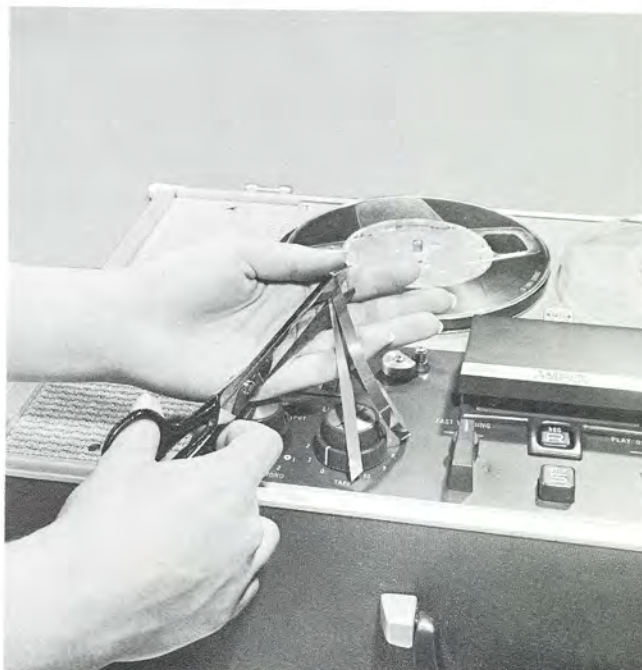

EDITING BY CUTTING

The recorded tape can also be edited by determining the portions to be deleted, physically cutting those portions out of the tape, and then splicing the program tape together. Note that this cannot be accomplished with a tape recorded in both directions, unless one side is sacrificed.

1. Cut the two ends of the tape as shown in figure at lower left.
2. Butt the ends of the tape together on a flat surface with the uncoated (shiny) side up.
3. Splice the joint with splicing tape, available at any audio shop.
4. Carefully trim the spliced area to the same width as the recorded tape.

An inexpensive tape splicer will aid you in making the correct splice.

An inexpensive tape splicer, available in any hi-fi shop, simplifies the procedures of tape editing.



PERFORMANCE CHARACTERISTICS

With the objective of a continuing improvement of its products, Ampex Audio Company reserves the right to modify specifications and designs as necessary, without incurring any obligation.

RECORDER/REPRODUCER



RECORDING INPUTS

High impedance line inputs (radio/TV/phono/auxiliary). Approx. 0.25 V rms for maximum normal recording level; high impedance microphone inputs 600 microvolts for normal operating level.

FREQUENCY RESPONSE

Within ± 2 db from 50 to 15,000 cps at 7 1/2 ips; 55 dynamic range.

Within ± 2 db from 50 to 8,000 cps at 3 3/4 ips, 50 db dynamic range.

LOAD IMPEDANCE

Recommended load impedance 250K ohms or greater, less than 2500 μ f.

FLUTTER AND WOW

Under 0.2 % rms at 7 1/2 ips.

Under 0.3% at 3 3/4 ips.

PLAYBACK OUTPUTS

Approximately 0.75 volts rms from cathode follower when using tapes recorded to maximum normal recording level.

HEADS

Manufactured to the same standards of precision that exist in Ampex broadcast and recording studio equipment. Surfaces are lapped flat within 10 millionths of an inch, resulting in uniform performance characteristics throughout the life of the head. Stereo head gap alignment: the one head gap in the stack with respect to the other is held within 20 seconds of arc, equivalent to less than 10 millionths of an inch — a degree of precision achieved through use of a unique process involving micro-accurate optical measurements within a controlled environment. Playback head gap length is 90 millionths of an inch.

PLAYING TIMES

	2-track stereo tapes	4-track stereo tapes	4-track monophonic tapes
1200' reel, 7 1/2 ips	32 minutes	1 hr 4 min	2 hrs 8 min
3 3/4 ips	1 hr 4 min	2 hrs 8 min	4 hrs 16 min
1800' reel, 7 1/2 ips	48 minutes	1 hr 36 min	3 hrs 12 min
3 3/4 ips	1 hr 36 min	3 hrs 12 min	6 hrs 24 min
2400' reel, 7 1/2 ips	1 hr 4 min	2 hrs 8 min	4 hrs 16 min
3 3/4 ips	2 hrs 8 min	4 hrs 6 min	8 hrs 32 min

AMPLIFIER/SPEAKER



The Ampex Model 2012 amplifier/speaker incorporates a high quality 10-watt (20 watts peak) amplifier which provides operating characteristics (unequalized) flat within ± 2.0 db throughout the maximum range of human hearing.

TOTAL HARMONIC DISTORTION

Less than 1% at rated output.

INPUT SENSITIVITY

0.25v to develop rated power.

SPEAKER

Eight-inch diameter; special Alnico V DG magnet; voice coil circuit coupled to first amplifier cathode through inverse feedback for improved damping and lower distortion.

MODEL 1270

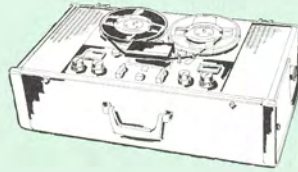

POWER LINE SUPPLY

117 volts, 1.4 amps, 60 cycle AC.

WEIGHT

48 pounds.

POWER AMPLIFIERS

AMPLIFIER OUTPUT IMPEDANCE (LABELED HEADSET OUTPUTS)

3.2 ohms.

SENSITIVITY

0.85 volts at 500 cycles for output across 3.2 ohm load of 1 1/2 watts per channel.

DISTORTION

Less than 2% total harmonic distortion of 500 cycles at rated power output.

FREQUENCY RESPONSE

(Tone control full clockwise for flat response.)
 ± 2 db from 50 to 10,000 cycles.

TONE CONTROL

Maximum attenuation (control full counter-clockwise) at 10 Kc is 18 ± 3 db.

HUM AND NOISE

Less than -60 dbm.

Mounting Dimensions

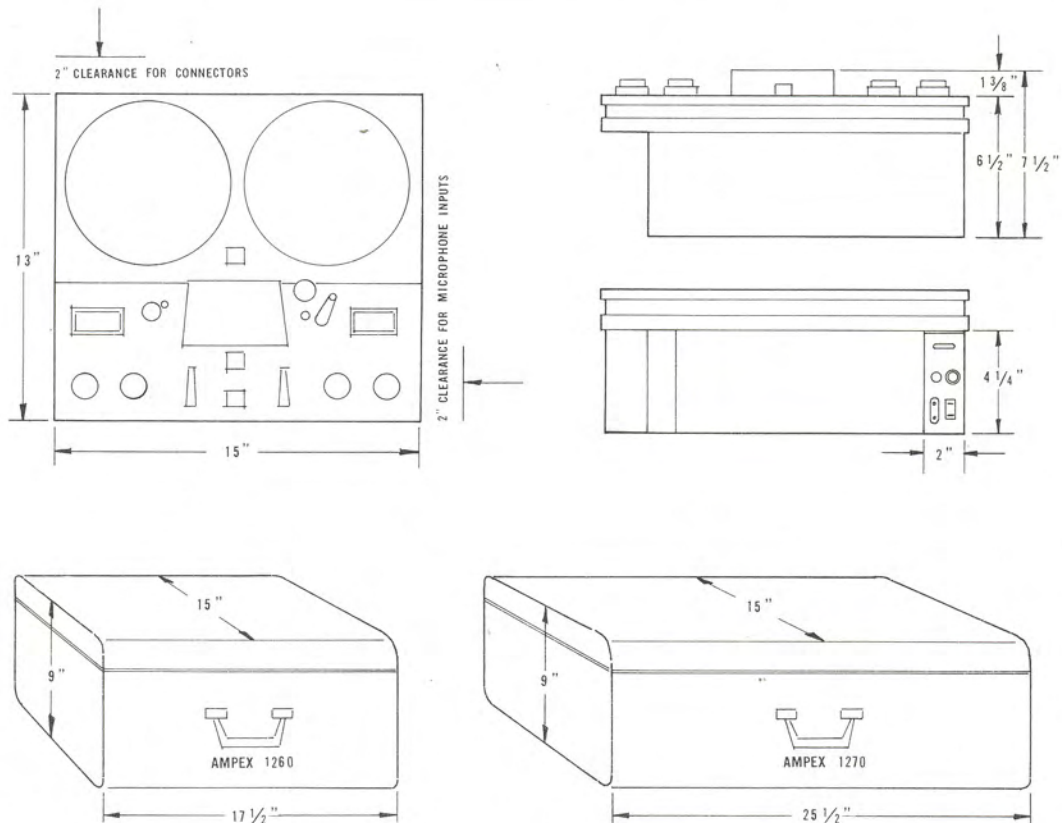

SCHEMATIC DIAGRAMS

RECORDER/REPRODUCERS

MODEL 1260

- NOTES**
1. SWITCHES SHOWN IN DOWN POSITION—7/2 I.F.S. POSITION—PLAYBACK POSITION.
 2. V1, V2, V3, V4, V9 = 12AX7
V5, V7, V12 = 6X4
V8 = 6X4
V6, V10 = 12AU7
 3. M = MEGOHM, K = 1000 OHM.
 4. ALL NON-ELECTROLYTIC CAPACITORS CAPACITY IN MICROCARADS UNLESS OTHERWISE NOTED.
 5. 1-2 & 1-3 ARE CONCENTRIC SWITCHES.
 6. ALL DC VOLTAGES TAKEN WITH RECORDER IN THE RECORD MODE AND MEASURED WITH A 20,000 OHM PER VOLT METER.
 7. ALL AC VOLTAGES MEASURED WITH AC VACUUM TUBE VOLTMETER (W-4000 OR EQUAL), 10 VOLT LINE. VOLUME CONTROLS SET TO FULL C.W. ROTATION AND MACHINE IN RECORD MODE WITH VIB REMOVED AND A 250 OHM RESISTOR SUBSTITUTED FOR THE 12AU7 TUBE. (PINS 1 AND 8 TIED TOGETHER AND THE RESISTOR FROM THIS JUNCTION TO PIN 3). GAIN MEASUREMENTS TAKEN AT 800 CYCLES WITH A 100 OHM RESISTOR SUBSTITUTED FOR RECORD HEAD. S2 IN TAPE POSITION, S3 IN ST1 RECD. POSITION.
 8. THESE CONTROLS ARE FACTORY ADJUSTED TO PROVIDE OPTIMUM PLAYBACK FREQUENCY RESPONSE.

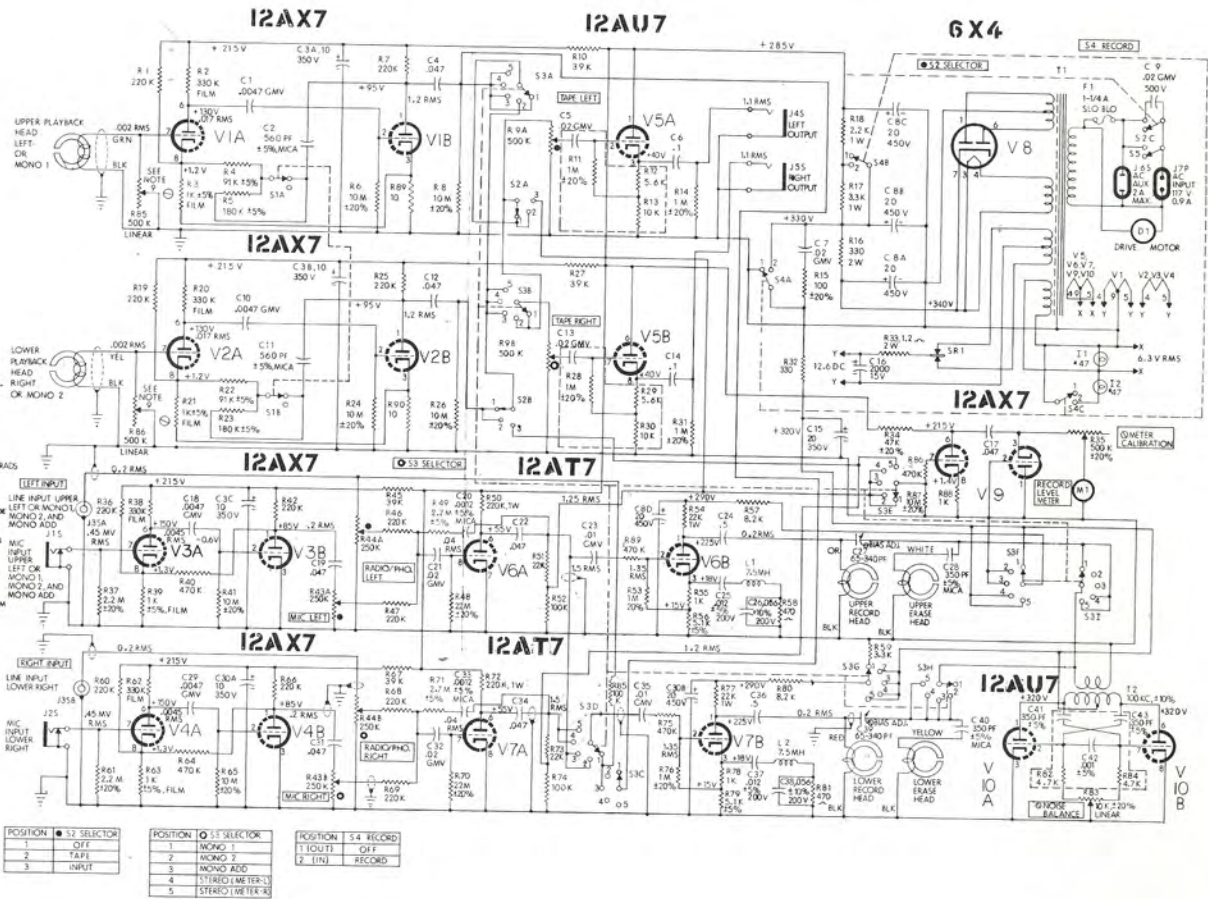

AMPLIFIER/SPEAKERS

MODEL 2012 Amplifier-Speaker

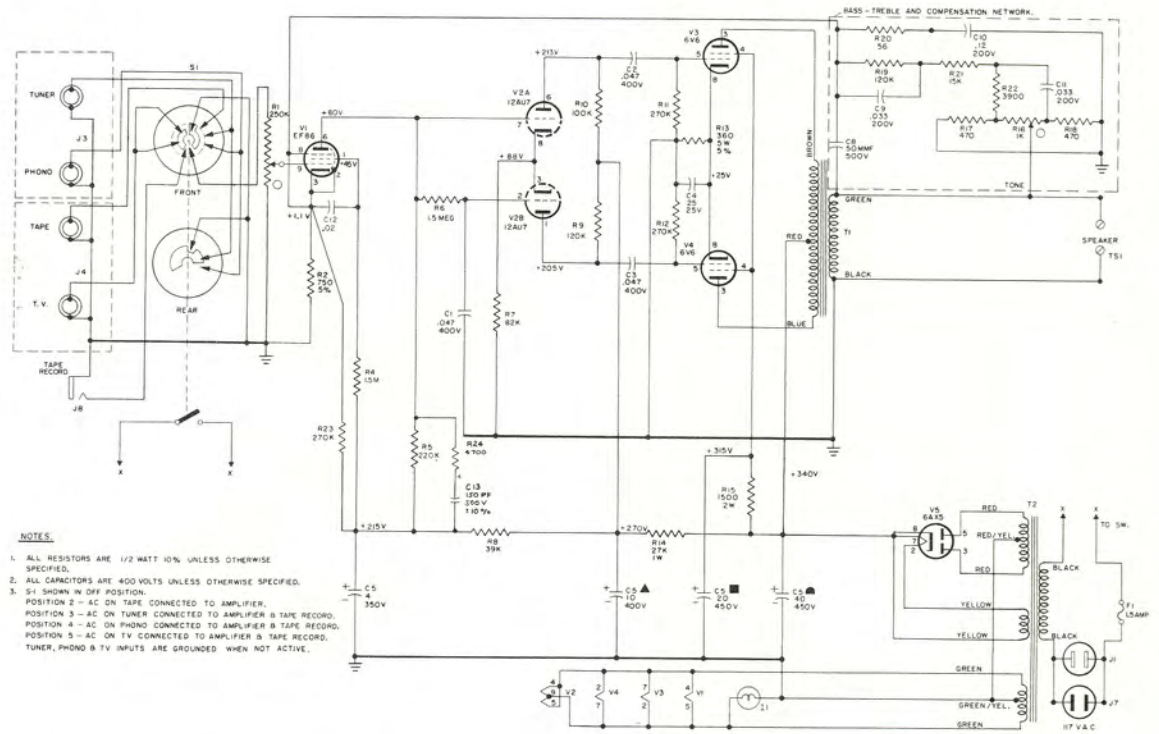

MODEL 1270 Monitor Amplifiers

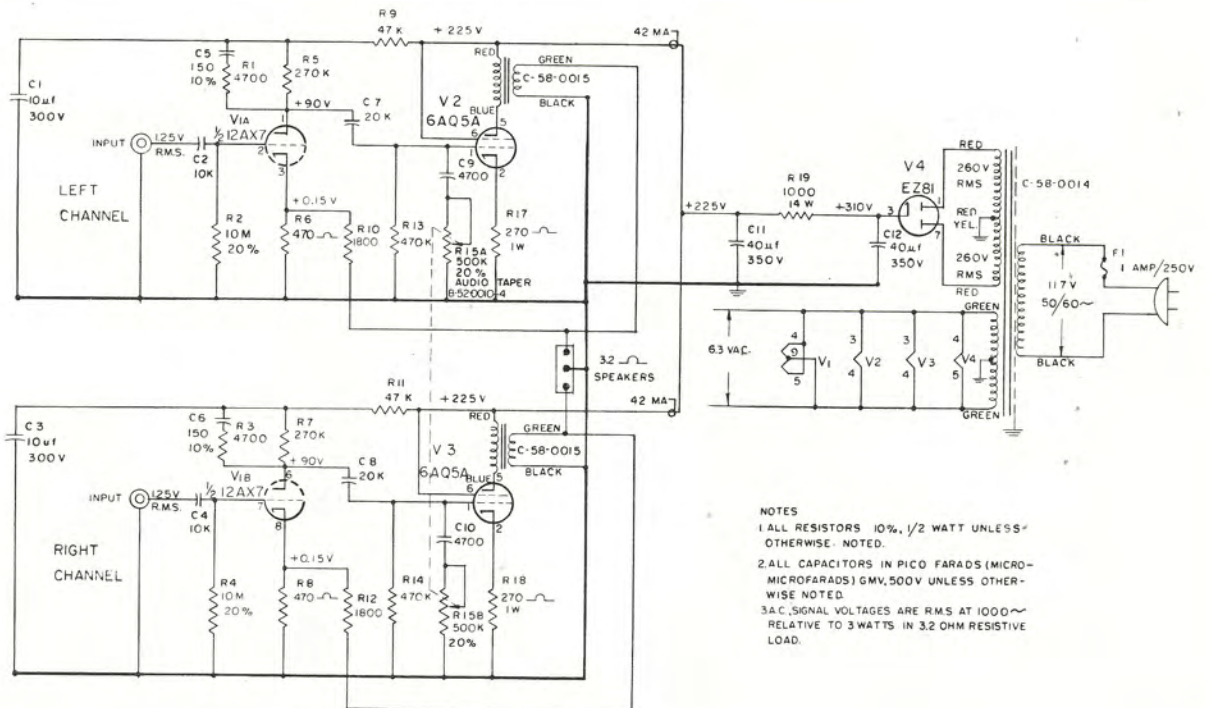

SCHEMATIC DIAGRAMS

RECORDER/REPRODUCERS

MODEL 1260

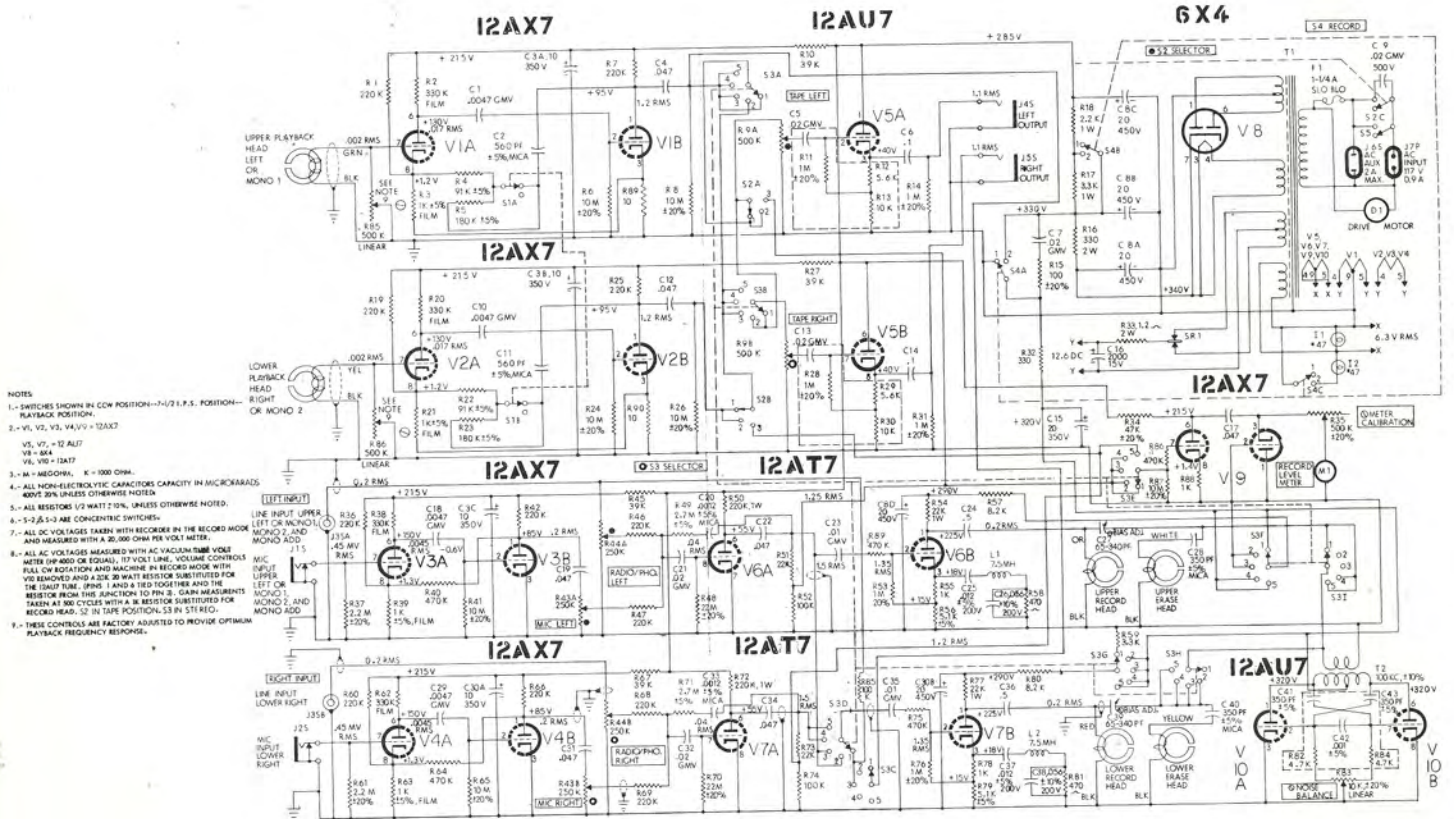

- NOTES
1. SWITCHES SHOWN IN COW POSITION—V1, V2, P.S. POSITION—PLAYBACK POSITION.
 2. V1, V2, V3, V4, V5 = 12AX7
 3. V6, V7, V8 = 12AU7
 4. V9 = 6X4
 5. V10 = 12AX7
 6. M = MEGOHM, K = 1000 OHM.
 7. ALL NON-ELECTROLYTIC CAPACITORS CAPACITY IN MICROSECONDS UNLESS OTHERWISE NOTED.
 8. ALL RESISTORS 1/2 WATT 10%, UNLESS OTHERWISE NOTED.
 9. S-1, S-2, S-3 ARE CONCENTRIC SWITCHES.
 10. ALL DC VOLTAGES TAKEN WITH RECORDER IN THE RECORD MODE AND MEASURED WITH A 20,000 OHM PER VOLT METER.
 11. ALL AC VOLTAGES MEASURED WITH AC VACUUM TUBE VOLT METER (IF 400 OR EQUAL), 10 VOLT LINE. VOLUME CONTROLS FULL CW ROTATION AND MACHINE IN RECORD MODE WITH VIB REMOVED AND A 150 OHM WATT RESISTOR SUBSTITUTED FOR VIB REMOVE AND THE JUNCTION TO PIN 8. GAIN MEASUREMENTS TAKEN AT 100 CYCLES WITH A 10 OHM RESISTOR SUBSTITUTED FOR RECORD HEAD. S2 IN TAPE POSITION, S3 IN STEREO.
 12. THESE CONTROLS ARE FACTORY ADJUSTED TO PROVIDE OPTIMUM PLAYBACK FREQUENCY RESPONSE.

POSITION	S1 SELECTOR	S2 SELECTOR	S3 RECORD
1	OFF	1 MONO 1	1 (OUT) OFF
2	TAPE	2 MONO 2	2 (IN) RECORD
3	INPUT	3 MONO ADD	
		4 STEREO (METER-L)	
		5 STEREO (METER-R)	

CONTROLS AND INDICATORS

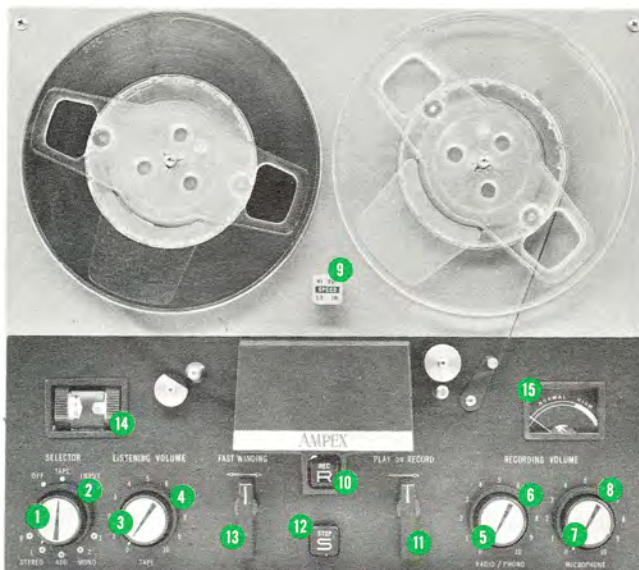

- 1 (Inside Knob) Switches recorder on. Selects monitoring of input or tape.
- 2 (Outside Knob) Selects monophonic or stereo recording and playback.
- 3 (Inside Knob) Adjusts listening volume for left-channel sound signal.
- 4 (Outside Knob) Adjusts listening volume for right-channel sound signal.
- 5 (Inside Knob) For external, phono or tuner inputs; adjusts level of sound being recorded on left channel.
- 6 (Outside Knob) For external, phono or tuner inputs; adjusts level at sound being recorded on right channel.
- 7 (Inside Knob) For left-channel microphone input; adjusts recording level.
- 8 (Outside Knob) For right-channel microphone input; adjusts recording level.
- 9 Selects tape speed: up position for 7 1/2 ips, down for 3 3/4 ips.
- 10 Recording pushbutton; safety-interlocked with #12—both must be actuated simultaneously to record.
- 11 Turn clockwise to move tape at normal speed from left to right. Locks machine in playback or recording mode of operation.
- 12 Stops tape motion whether recording or reproducing (playing back), regardless of direction or speed.
- 13 Moves the tape rapidly in either direction. Turn knob in direction you want tape to go.
- 14 Indicates tape position, enables you to return to pre-determined place on the tape.
- 15 Indicates recording level of either left or right channel as selected by control #2.

OWNER'S WARRANTY

SERIES 1200

WELCOME TO THE GROWING FAMILY OF AMPEX OWNERS. You have purchased one of the finest pieces of equipment of its kind available today. This recorder was accurately adjusted, carefully inspected and thoroughly tested before shipment from the factory and found to meet the recognized high quality standards of Ampex products. If it does not function properly or if there is some question about how it should operate, read your instruction book carefully—you may find that it can be easily corrected.

Ampex Audio Company warrants to the purchaser of each new Ampex recorder-reproducer and/or Amplifier Speaker that any part thereof (with the exception of tubes) which proves to be defective in material or workmanship within ninety (90) days from the date of original purchase for use will be repaired or replaced in accordance with the terms of this warranty.

If any part except tubes should prove to be defective during the aforementioned ninety-day period, such defects should be brought to the attention of the Ampex Audio dealer from whom the equipment was purchased. If upon examination the part is determined to be defective in material or workmanship, the dealer will replace the defective part at no charge. The responsibility of Ampex Audio Company is limited to making a new or factory-reconditioned replacement part available to the dealer through an Ampex Audio Authorized Service Center. It is the responsibility of the dealer to replace defective parts, either by his own service personnel or through an Ampex Audio Authorized Service Center.

The foregoing is in lieu of all other warranties, expressed, implied or statutory and Ampex Audio Company neither assumes nor authorizes any person to assume for it any other obligation or liability in connection with said equipment.

THIS WARRANTY IS EFFECTIVE ONLY WHEN ACCOMPANYING CARD IS FULLY AND PROPERLY FILLED OUT AND RETURNED TO FACTORY WITHIN TEN (10) DAYS OF ORIGINAL PURCHASE DATE.

AMPEX

AMPEX

OWNERS MANUAL AND WARRANTY
ENCLOSED